

Scotsman[®]

SERVICE MANUAL

DXN 107

DXN 207

R290 Version

Electronic counter cubelet ice dispenser

Scotsman Ice Srl
Via Lainate, 31 - 20010 Pogliano M.se - Milano - Italy
Tel. +39-02-93960.1 (Aut. Sel.)- Telefax +39-02-93550500
Direct Line to Service & Parts:
Phone +39-02-93960350 - Fax +39-02-93540449
Website: www.scotsman-ice.it
E-Mail: scotsman.europe@scotsman.it



REV. 11/2018

**TABLE OF
CONTENTS**

Table of contents	page	2
Specifications DXN 107		3
Specifications DXN 207		5
GENERAL INFORMATION AND INSTALLATION		
Introduction		7
Unpacking and Inspection		7
Location and levelling		7
Electrical connections		7
Water supply and drain connections		8
Final check list		8
OPERATING INSTRUCTIONS		
Start up		9
Operational checks		9
PRINCIPLE OF OPERATION (How it works)		
Water circuit		11
Refrigerant circuit		11
Mechanical system		12
Operating pressures		12
Components description		13
WIRING DIAGRAM AND SERVICE DIAGNOSTIC		
Wiring diagram - Dispensing board version		18
Service diagnosis		20
MAINTENANCE AND CLEANING INSTRUCTIONS		
General		22
Cleaning instructions of water system		25

SPECIFICATIONS

ELECTRONIC COUNTER CUBELET DISPENSER DXN 107

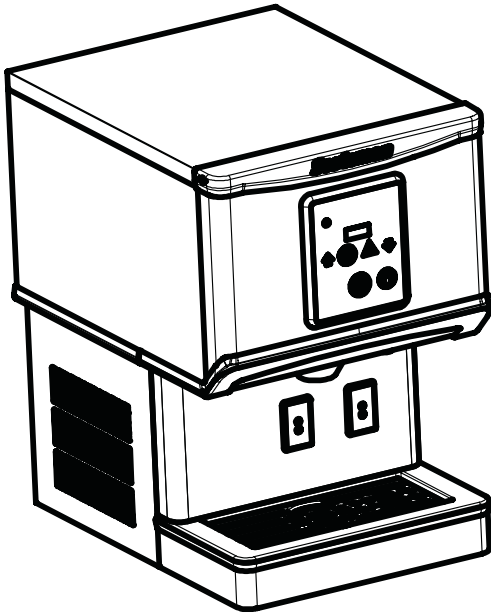

Important operating requirements:

	MIN	MAX
- Air temperature	10°C (50°F)	38°C (100°F)
- Water temperature	10°C (50°F)	35°C (95°F)
- Water pressure	1 bar (14 psi)	5 bars (70 psi)
- Electr. voltage variations from voltage rating specified on nameplate	-10%	+10%

ice making capacity

AIR COOLED MODELS

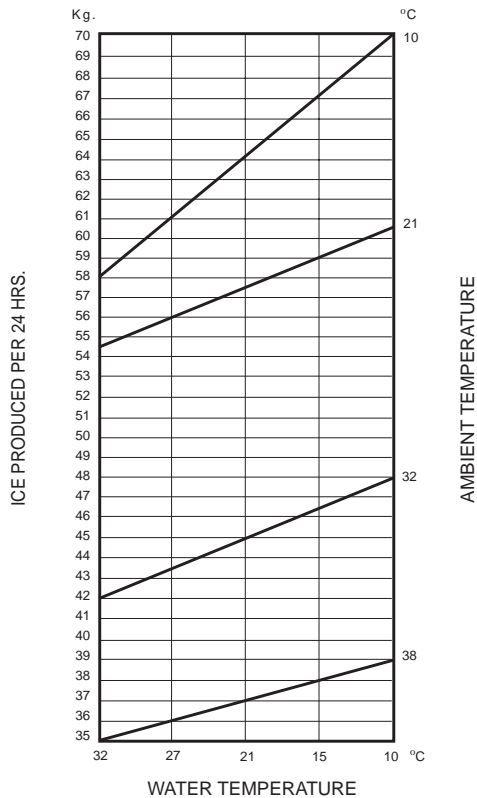

NOTE. The daily ice-making capacity is directly related to the condenser air inlet temperature, water temperature and age of the machine.
 To keep your **SCOTSMAN CUBELET DISPENSER** at peak performance levels, periodic maintenance checks must be carried out as indicated on page 22 of this manual.

SPECIFICATIONS

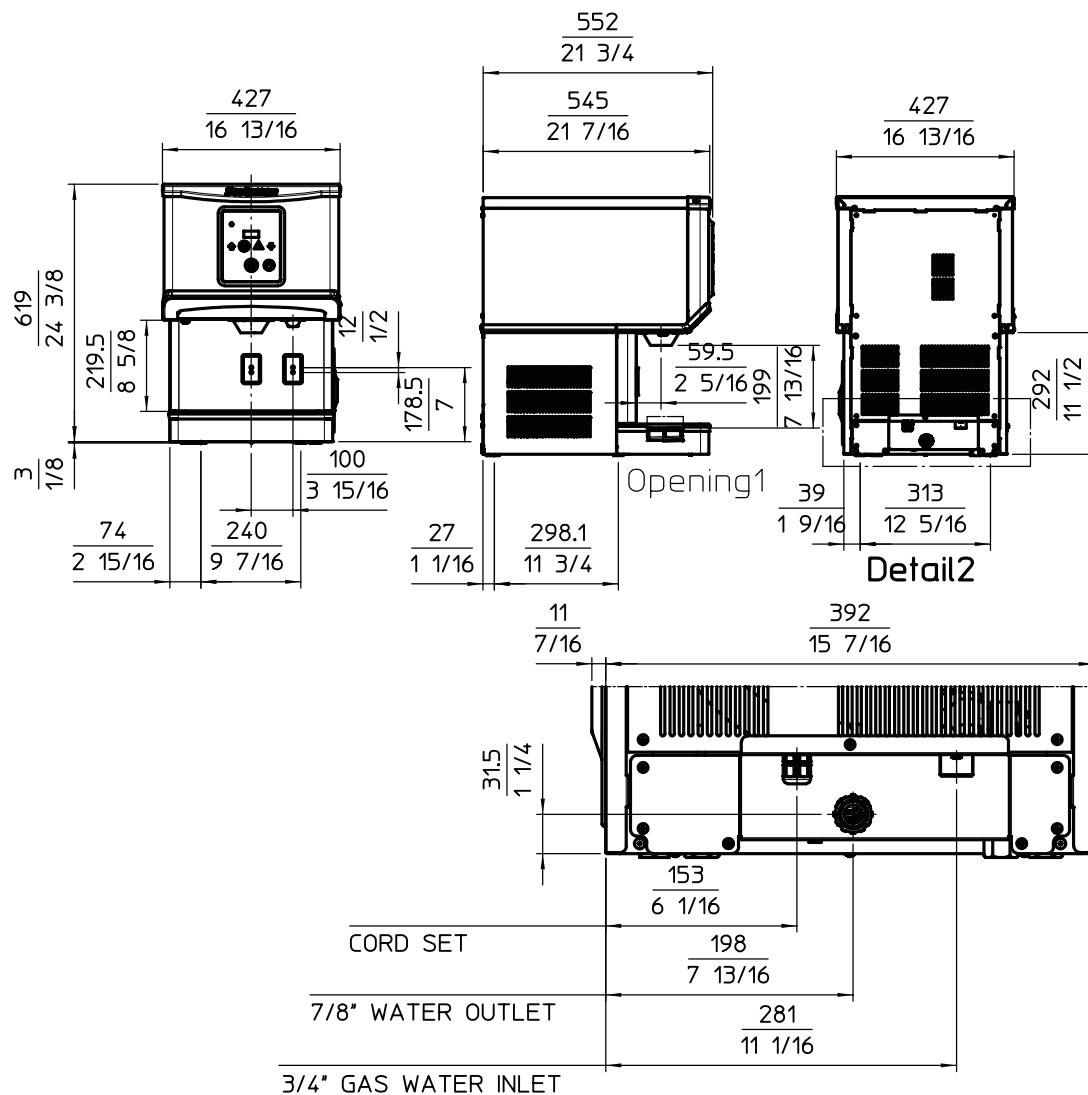

DXN 107 - MACHINE SPECIFICATIONS

Model	Cond. unit	Finish	Ice bin cap	Water req. lt/24 HR (*)		
DXN 107 AS	Air	S. Steel	5 Kg	44,5		
Basic electr.	Amps	Start Amps	Watts (*)	Electric power cons. Kwh per 24 HR	Nr. of wires	Amps fuse
230/50/1	0,5	N.A.	300	7,2	3 x 1.5 mm ²	10

(*) Ambient t. 32°C / Water t. 21°C

SPECIFICATIONS

ELECTRONIC COUNTER CUBELET DISPENSER DXN 207

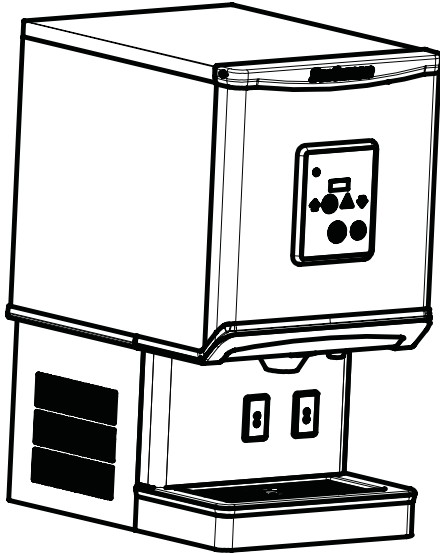

Important operating requirements:

	MIN	MAX
- Air temperature	10°C (50°F)	38°C (100°F)
- Water temperature	10°C (50°F)	35°C (95°F)
- Water pressure	1 bar (14 psi)	5 bars (70 psi)
- Electr. voltage variations from voltage rating specified on nameplate	-10%	+10%

ice making capacity

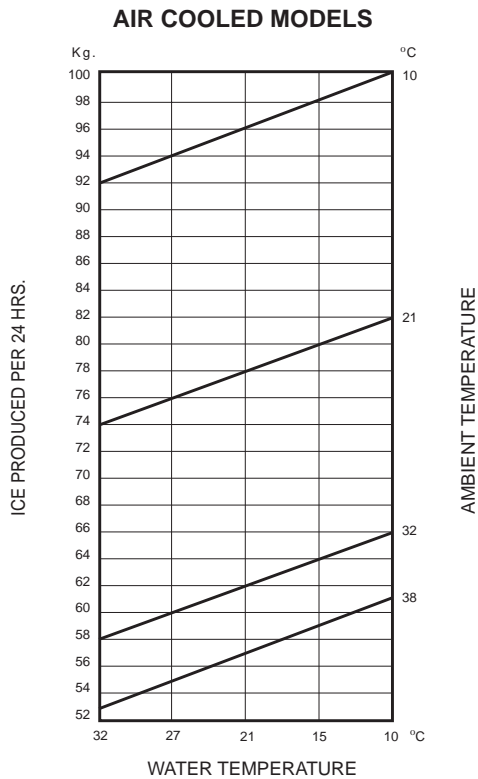

NOTE. The daily ice-making capacity is directly related to the condenser air inlet temperature, water temperature and age of the machine.
 To keep your **SCOTSMAN CUBELET DISPENSER** at peak performance levels, periodic maintenance checks must be carried out as indicated on page 22 of this manual.

SPECIFICATIONS

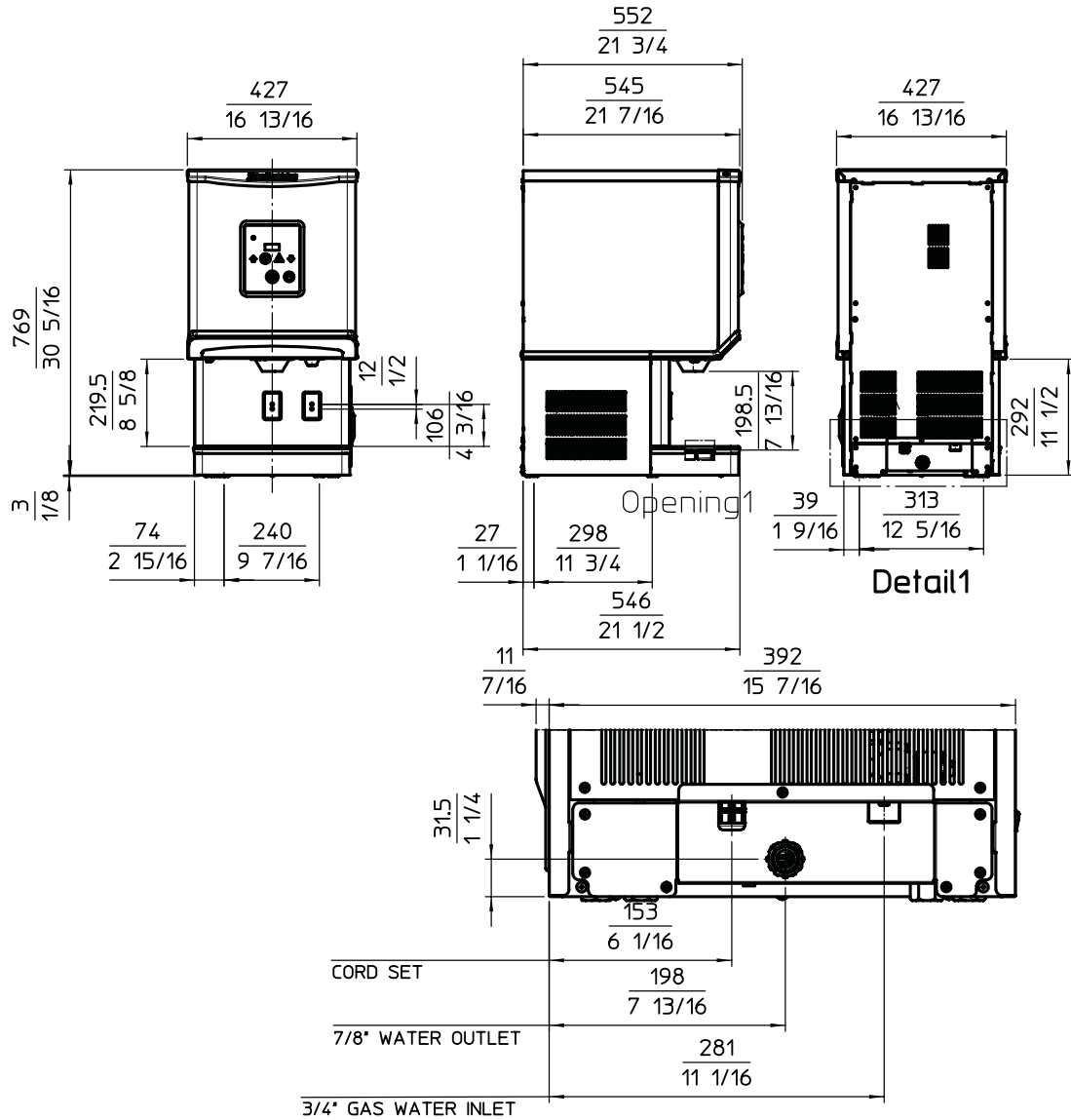

Detail1 - Connection support

DXN 207 - MACHINE SPECIFICATIONS

Model	Cond. unit	Finish	Ice bin cap	Water req. lt/24 HR (*)
DXN 207 AS	Air	S. Steel	10 Kg	62,2

Basic electr.	Amps	Start Amps	Watts	Electric power cons. Kwh per 244 Kg	Nr. of wires	Amps fuse
230/50/1	2,9	20	600	13,6	3 x 1.5 mm ²	10

(*) Ambient t. 32°C / Water t. 21°C

GENERAL INFORMATION AND INSTALLATION

A. INTRODUCTION

This manual provides the specifications and the step-by-step procedures for the installation, start-up and operation, maintenance and cleaning for the **SCOTSMAN DXN 107 and DXN 207** counter cubelet ice dispensers. Their ice making systems are thoroughly tested providing the utmost in flexibility to fit the needs of a particular user.

NOTE. To retain the safety and performance built into this icemaker, it is important that installation and maintenance be conducted in the manner outlined in this manual.

B. UNPACKING AND INSPECTION

1. Call your authorized SCOTSMAN Distributor or Dealer for proper installation.
2. Visually inspect the exterior of the packing and skid. Any severe damage noted should be reported to the delivering carrier and a concealed damage claim form filled in subject to inspection of the contents with the carrier's representative present.
 - a) Cut and remove the plastic strip securing the carton box to the skid.
 - b) Cut open the top of the carton and remove the polystyrene protection sheet.
 - c) Pull out the polystyrene posts from the corners and then remove the carton.
4. Remove the top and sides panels of the unit and inspect for any concealed damage. Notify carrier of your claim for the concealed damage as stated in step 2 above.
5. Remove all internal support packing and masking tape.
6. Check that refrigerant lines do not rub against or touch other lines or surfaces, and that the fan blades move freely.
7. Check that the compressor fits snugly onto all its mounting pads.
8. Use clean damp cloth to wipe the surfaces outside of the cabinet.
9. See data plate on the rear side of the unit and check that local main voltage corresponds with the voltage specified on it.

CAUTION. Incorrect voltage supplied to the icemaker will void your parts replacement program.

10. Remove the manufacturer's registration card from the inside of the User Manual and fill-in all parts including: Model and Serial Number taken from the data plate. Forward the completed self-addressed registration card to SCOTSMAN factory.

C. LOCATION AND LEVELLING

WARNING. This Ice Dispenser is designed for indoor installation only. Extended periods of operation at temperature exceeding the following limitations will constitute misuse under the terms of the SCOTSMAN Manufacturer's Limited Warranty resulting in LOSS of warranty coverage.

1. Position the unit in the selected permanent location. Criteria for selection of location include:

	Min	Max
Air Temperature	10°C	38°C
Water Temperature	10°C	35°C
Water pressure	1 bar	5 bar
Voltage	-10%	+10%

(Compared to the nameplate)

Service access: adequate space must be left for all service connections through the rear of the ice maker.

This machine is air cooled and sucks air through the right side panel and blows air out the rear and left side panels. Do not install the machine where the right side air flow might be blocked.

It is important that the machine be installed in a location where it has enough space around it to be accessible for service, and minimum of 15 cm be allowed at all sides for air circulation. Try to avoid hot, dirty and crowded locations.

NOTE. It is imperative to do not place on top of the machine any sort of goods.

D. ELECTRICAL CONNECTIONS

See data plate for current requirements to determine wire size to be used for electrical connections. All SCOTSMAN icemakers require a solid earth wire. All SCOTSMAN ice machines are supplied from the factory completely pre-wired and require only electrical power connections to the wire cord provided at the rear of the unit. Make sure that the ice machine is connected to its own circuit and individually fused (see data plate for fuse size). The maximum allowable voltage variation should not exceed -10% and +10% of the data plate

rating. Low voltage can cause faulty functioning and may be responsible for serious damage to the overload switch and motor windings.

NOTE. All external wiring should conform to national, state and local standards and regulations.

Check voltage on the line and the ice maker's data plate before connecting the unit.

E. WATER SUPPLY AND DRAIN CONNECTIONS

GENERAL

When choosing the water supply for the ice flaker consideration should be given to:

- a) Length of run
- b) Water clarity and purity
- c) Adequate water supply pressure

Since water is the most important single ingredient in producing ice you cannot emphasize too much the three items listed above.

Low water pressure, below 1 bar may cause malfunction of the ice maker unit.

Water containing excessive minerals will tend to produce scale build-up on the interior parts of the water system while too soft water (with too low contents of mineral salts), will produce a very hard flaker ice.

PLUMBING CONNECTIONS MUST CONFORM TO ALL APPLICABLE CODES

CONNECT TO POTABLE WATER ONLY

DXN 107 - 207 have the possibility to have the water connections through the bottom base or through the rear bottom side of the machine. In this second case it is necessary to remove the rear bottom small panel.

WATER SUPPLY

Connect the 3/4" GAS male of the water inlet fitting, using the flexible tube supplied to the cold water supply line with regular plumbing fitting and a shut-off valve installed in an accessible position between the water supply line and the unit.

If water contains a high level of impurities, it is advisable to consider the installation of an appropriate water filter or conditioner.

WATER DRAIN

The recommended drain tube is a plastic or flexible tube with 18 mm (3/4") I.D. which runs to an open trapped and vented drain. When the drain is a long run, allow 3 cm pitch per meter (1/4" pitch per foot).

Install a vertical open vent on drain line high point at the unit drain connection to ensure good draining.

The ideal drain receptacle is a trapped and vented floor drain.

NOTE. The water supply and the water drain must be installed to conform with the local code. In some case a licensed plumber and/or a plumbing permit is required.

F. FINAL CHECK LIST

1. Is the unit in a room where ambient temperatures are within a minimum of 10°C (50°F) even in winter months?
2. Is there at least a 15 cm (6") clearance around the unit for proper air circulation?
3. Is the unit level?
4. Have all the electrical and plumbing connections been made, and is the water supply shut-off valve open?
5. Has the voltage been tested and checked against the data plate rating?
6. Has the water supply pressure been checked to ensure a water pressure of at least 1 bar (14 psi).
7. Check all refrigerant lines and conduit lines to guard against vibrations and possible failure.
8. Has the owner/user been given the User Manual and been instructed on the importance of periodic maintenance checks?
9. Has the Manufacturer's registration card been filled in properly? Check for correct model and serial number against the serial plate and mail the registration card to the factory.
10. Has the owner been given the name and the phone number of the authorized SCOTSMAN Service Agency serving him?

OPERATING INSTRUCTIONS

After having correctly installed the ice dispenser and completed the plumbing and electrical connections, perform the following Start-Up procedure

START UP

A. Open the water supply shutoff valve and give power by the ON/OFF push button, the machine enters in the starting delay time with Gear Reducer always in operation and two complete purge and refill of the water reservoir, **d01** (purge time) and **d02** (refill time) code monitor this condition on display.

NOTE: Every time the unit is put under power, after being kept for some time in shut-off conditions (electrically disconnected) the delay starting period will be 15 minutes. The machine will run an auto calibration of ice level control showing **F02** code for few seconds. Every restart from other operating conditions with the unit electrically connected it will take only 3 minutes of delay

B. Elapsed the starting delay time, the unit starts operating (**F04** code appears on display for few seconds) with the activation in sequence of the following components:

COMPRESSOR

FAN MOTOR Kept under control by the condenser temperature sensor which has its probe within the condenser fins.

The Bin Empty light is ON during all start up/delay time and for the first minutes of operation.

NOTE ONLY FOR AUTHORIZED TECHNICIAN

To by-pass the start-up delay perform the following procedure:

- During the delay time press and hold for 5 seconds both ICE and WATER capacitive keys simultaneously then release.
- As soon as "tSt" will appear on display keep pressed the same capacitive keys until the units starts the operation.

C. Five minutes after the compressor start up, the ice begins dropping down in the storage bin, ice can be dispensed as soon as the Bin Empty light disappear.

D. The unit will stop the operation when the storage bin is full of ice and the infrared beam of the ice level control is interrupted for 10 seconds continuously.

E. Every 12 hours of operation the units will make an automatic purge and refill of the water reservoir and freezer to prevent the growth of bacteria and algae when machine is not working for many hours (Night-time and/or Bin full condition).

OPERATION CHECKS UPON THE UNIT START UP

F. Remove service panels and if necessary install the refrigerant service gauges on the corresponding Service valves to check both the HI and LO refrigerant pressures.

NOTE. The condenser temperature sensor, which is located within the condenser fins, keeps the head (condensing) pressure between two preset values.

In case of condenser clogging such to prevent the proper flow of the cooling air or, in case the fan motor is out of operation, the condenser temperature rises and when it reaches **70°C (160°F)** the condenser temperature sensor shuts-off the ice maker with the consequent light-up of ALARM CODE A08. After having diagnosed the reason of the temperature rise and removed its cause, it is necessary to proceed as per the previous "NOTE" to start up again the operation of the ice maker.

NOTE. If, after ten minutes from the compressor start-up, the evaporating temperature has not dropped down to a value lower than **-0°C (30°F)** the evaporating temperature sensor detects such an abnormal situation and stops consequently the unit operation.

In this circumstance, the ALARM CODE A06. After having diagnosed and eliminated the cause of the poor evaporating temperature (insufficient refrigerant in the system or inoperative compressor or evaporator sensor) it is necessary to restart the unit. The unit, before resuming the total operation, will go through the usual **STAND-BY** period.

G. Check for the correct CUT-OUT and CUT-IN of the float reservoir water level sensors by shutoff the valve on the water supply line. This will cause a gradual decrease of the water level in the float reservoir and as soon as the level gets below the sensors, the unit stops to operate and the ALARM CODE A01 will glow on display.

NOTE. The water level sensor detects the presence of sufficient water in the float reservoir and confirms it to the micro processor by maintaining a low voltage current flow between the two sensors using the water as conductor.

WARNING. The use of de-mineralized water (water with no salt content) having an electrical conductivity lower than **30 µS**, will cause the ability of the water sensors to vanish with the consequent CUT-OUT of the flaker operations and the glowing of the ALARM CODE A01 of shortage of water, even though that water is indeed in the reservoir.

After this, open the water supply line shutoff valve to fill up again the float reservoir.

After 10 minutes the unit resumes its total operation with the immediate start-up of the gear motor and, 2 seconds later, of the compressor.

H. Check for the correct operation of the electronic eye for the ice bin level control, by placing one hand between the sensing “eyes” located under the storage bin cover, to interrupt the light beam. This interruption after 10 seconds causes the shutoff of the unit. Allow the resumption of the light beam previously interrupted and after 10 seconds the unit will resume - through the 3 minutes STAND-BY period - ice making process.

NOTE. *The ICE LEVEL CONTROL (INFRA-RED SYSTEM) is independent of the temperature however, the reliability of its detection can be affected by dirt and scale sediment which may deposit directly on the light source and on the receiver.*
To prevent any possible ice maker malfunction, due to negative affection of the light detector, it is advisable to follow the instructions for the periodical cleaning of the light sensor elements as detailed in the MAINTENANCE AND CLEANING PRO-CEDURES.

I. SETTING OF ICE DISPENSING TIME (ONLY ICE)

The dispensing time of the ice is factory set at 3” but it is possible to modify it choosing between:

- From 1” up to 15”
- Continuous

To change this time perform the following procedure:

Open the water supply line shutoff valve and give power by moving the main switch to ON position and push green ON/OFF button on the machine.

Push the Red Alarm button on the display for 10 seconds to enter in the Program Menu, use the arrows to select “S” then press ICE button to confirm

Press arrow to select time 1..2..3.. up to 15 seconds or CON for Continuous , then push ICE to confirm.

Push WATER button for 5 seconds to ESC.

J. SETTING OF DISPENSING MODE

The unit can dispense ice only or ice and water and it is also possible modify this setting performing the following procedure:

Push the Red Alarm button on the display for 10 seconds to enter in the Program Menu, use the arrows to select “H” then press ICE button to confirm

Press arrows to select “on” for dispensing water activated or “off” for dispensing water disabled, then push ICE to confirm.

Push WATER button for 5 seconds to ESC.

K. SETTING OF THE DISPENSING OPERATION

DXN can be provided with two different versions:

- **Touch** (No Optical Dispensing Devices installed)

- **Touchless** (With Optical Dispensing Devices installed)

The initial setting is already made in factory according with the version of the unit, in case of replacement of the P.C. Board perform the following procedure to set up the dispensing operation accordingly:

Push the Red Alarm button on the display for 10 seconds to enter in the Program Menu, use the arrows to select “F” then press ICE button to confirm

Press arrows to select “tch” for Touch version or “tcl” for Touchless version , then push ICE to confirm.

Push WATER button for 5 seconds to ESC.

L. CHECK OF THE DISPENSING OPERATING MECHANISM

After having properly completed the above set up procedures, check the correct operation of the dispensing mechanism:

Touchless Version:

- a) Place a glass or carafe in front of one of the two Optical Dispensing Devices (Ice and/or Water)
- b) The dispensing drive motor and/or the water solenoid valve starts to operate with ice and/or water discharged through the bottom plastic spouts
- c) The drive motor remains in operation as per setting dispensing time; the water inlet solenoid valve remains in continuous operation unless the glass of carafe is removed.

Touch Version:

- d) Place a glass or carafe under the plastic spouts (Ice and/or Water)
- e) Push ICE or WATER button , the dispensing drive motor and/or the water solenoid valve starts to operate with ice and/or water discharged through the bottom plastic spouts
- c) The drive motor remains in operation as per setting dispensing time; the water inlet solenoid valve remains in continuous operation unless the WATER button is released.

NOTE. *When ice is not dispensed for more than 30 minutes with the dispenser in operation and compressor energized, the drive motor will be activated for two seconds to rotate the vane in order to prevent ice block in the bin and optimize the ice level in the storage bin.*

M. If previously installed, remove the refrigerant service gauges and re-fit the unit service panels previously removed.

N. Instruct the owner/user on the general operation of the ice machine and about the cleaning and care it requires.

PRINCIPLE OF OPERATION

WATER CIRCUIT

The water enters in the machine through the water inlet valve (which incorporates a strainer and it is located at the rear side of the cabinet) and then it goes to the water reservoir flowing through a float valve.

NOTE. The presence of the water in the float reservoir is detected by a system of two sensors which operates in conjunction with the P.C. Board. The two sensors use the water as a conductor to maintain a low voltage current flow between them. In case the water used is very soft (de-mineralized) or the float reservoir gets empty the current flow between the sensors becomes so weak or is no longer maintained that, as consequence, the P.C. Board shuts off the operation with the simultaneous glowing of the **A01** signalling "Shortage of water".

The float reservoir is positioned at the side of the freezing cylinder at such a height to be able to maintain a constant water level around the freezer auger. In fact, the water flows from the reservoir into the bottom inlet of the freezing cylinder to surround the stainless steel auger which is vertically fitted in the center of the freezer. In the freezer the incoming water gets chilled into soft (slush) ice which is moved upward by the rotating action of the auger. The stainless steel auger that rotates counter-clockwise within the freezer, is powered by a direct drive gear motor and carries the ice upward along the refrigerated freezer inner walls and by doing so the ice gets progressively thicker and harder.

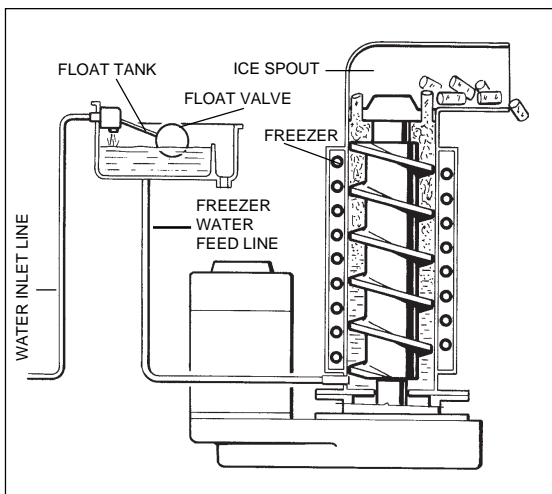

The ice, being constantly lifted up, meets the tooth of the ice breaker which is fitted on the top end of the auger, where it gets compacted, cracked and forced to change from vertical into horizontal motion to be discharged out, through the ice spout, into the storage bin.

By running the ice maker, i.e. by putting the unit under power, starts the automatic and continuous icemaking process which would not stop until the ice storage bin gets filled-up to the level of the control "eyes" located under the storage bin cover.

As the ice level raises to interrupt the light beam running between the two infrared lamps, the unit stops after ten seconds (compressor first and 3 minutes later the gear reducer).

NOTE. After about **10"** of **steady interruption** of the light beam the unit stops and the **bf1** glows on display.

The 10 seconds of delay prevent the unit from stopping for any undue reason like the momentarily interruption of the light beam caused by the flakes that slides along the ice spout before dropping into the bin.

As some ice is dispensed from the storage bin, the light beam between the two sensors resumes and ten seconds later the ice machine restarts the ice making process.

REFRIGERANT CIRCUIT

The hot gas refrigerant discharged out from the compressor reaches the condenser where, being cooled down, condenses into liquid.

Flowing into the liquid line it passes through the drier filter, then it goes all the way through the capillary tube where it loses some of its pressure so that its pressure and temperature are lowered. Next, the refrigerant enters into the evaporator.

The water being constantly fed at the interior of the freezer inner tube, exchange heat with the refrigerant circulating into the evaporator, this causes the refrigerant to boil-off and evaporate, thereby it changes from liquid into vapor.

The vapor refrigerant then passes through the suction accumulator and through the suction line where the refrigerant exchanges heat with the one flowing into the capillary tube (warmer) before being sucked into the compressor to be recirculated.

The refrigerant heat pressure is kept between two pre-set values by the condenser temperature sensor which has its probe located within the condenser fins - in air cooled versions.

This condenser temperature sensor, when senses a rising of the condenser temperature beyond the pre-fixed limit, changes its electrical resistance and sends a low voltage power flow to the MICRO-PROCESSOR of the P.C. Board which energizes, through a **TRIAC**, the **Fan Motor in ON-OFF mode**.

When the opposite situation occurs, i.e. the condenser temperature gets below the pre-fixed

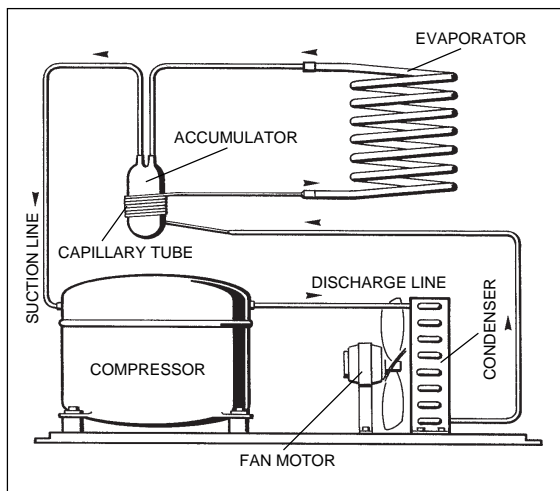

limit, the temperature sensor changes again its electrical resistance reducing therefore the current flow to the P.C. Board to cause a temporary stop of the Fan Motor.

NOTE. In case the condenser temperature probe senses that the condenser temperature has risen to **70°C (160°F)** for one of the following abnormal reasons:

CLOGGED CONDENSER
FAN MOTOR OUT OF OPERATION
AMBIENT TEMPERATURE HIGHER THEN 38°C (100°F)

it causes the total and immediate SHUT-OFF of the machine in order to prevent the unit from operating in abnormal and dangerous conditions. When the ice maker stops on account of this protective device, there is a simultaneous glowing of the **A08**, warning the user of the **Hi Temperature** situation. After having eliminated the source of the excessive condenser temperature, to restart the ice machine it is necessary to push the **GREEN ON/OFF** button.

NOTE. If, after ten minutes from the unit start up, no ice is made and the evaporating temperature detected by the evaporator sensor results to be higher than **-0°C (30°F)** the ice maker stops and the **A06** glows on display.

MECHANICAL SYSTEM

The mechanical system of the SCOTSMAN Ice Dispenser consists basically of a gear motor assembly which drives, a worn shaft or auger placed on its vertical axis within the freezing cylinder.

The gear motor is made of a single phase electric motor with a permanent capacitor. This motor is directly fitted in the gear case through which it drives - in counter clockwise rotation at a speed of 10 r.p.m. - the freezer auger being linked to it.

NOTE. In the event the gear motor will tend to rotate slowly or not rotating at all the unit will **stop immediately** with the glowing of the **A10 Alarm Code** on display on account of the intervention of the **Electromagnetic Safety Device** - based on Hall Effect principle. After having diagnosed and eliminated the source of the failure, to restart the unit it is necessary to press the **GREEN ON/OFF** button.

When the gear motor rotating speed is slowed below **360 r.p.m.** from the normal speed of 1300 r.p.m. the Electromagnetic Safety Device transmits an electrical signal to the MICROPROCESSOR to **stop immediately** the unit operations like it occurs for the wrong rotation, with the lighting-up of the **A10 Alarm Code**. This to relieve from the excessive load all the electrical and mechanical components of the entire Drive System and extend their durability.

NOTE. After having diagnosed and eliminated the source of the gear motor slow rotation to restart the unit it is necessary to press the **GREEN ON/OFF** button.

NOTE. Any time the machine stops in alarm the **RED** alarm capacitive key will be ON.

REFRIGERANT METERING DEVICE:

capillary tube

OPERATING PRESSURES

(With 21°C ambient temperature)

	DXN 107	DXN 207
Discharge pressure:	12,0 bar	11,3 bar
Suction pressure:	2,8 bar	1,5 bar

REFRIGERANT CHARGE (R 452A):

DXN 107	65 gr
DXN 207	65 gr

NOTE. Before charging the refrigerant system always check the type of refrigerant and quantity as specified on the individual ice machine dataplate.

The refrigerant charges indicated are relatives to averages operating conditions.

COMPONENT DESCRIPTION

A. EVAPORATOR TEMPERATURE SENSOR - BLACK 2 POLES CONNECTOR - MANUAL RESET

The evaporator sensor probe is inserted into its tube well, which is welded on the evaporator outlet line. It detects the temperature of the refrigerant on the way out from the evaporator and signals it by supplying a low voltage current flow to the P.C. Board Micro-Processor.

According to the current received, the micro-processor let the ice maker to continue its operations or not. In case the evaporating temperature, after 10 minutes from the unit start-up, does not go below 0°C (32°F) the evaporator sensor signal reaching the microprocessor is such to stop immediately the unit operation, with the AØ2 Alarm Code on display.

B. WATER LEVEL SENSOR - RED TWO POLES CONNECTOR - AUTOMATIC RESET

This sensor system consist of two small stainless steel rods vertically fitted on the inner face of the reservoir cover and electrically connected to the low voltage circuit of the P.C. Board. When the cover of the reservoir is positioned in its place the tips of both the rods dip into the reservoir water and detects and signals its presence by supply power back to the P.C. Board.

NOTE. In the event of **shortage of water** in the reservoir or, in case the water used is too soft (de-mineralized) to cause greater resistance to the current flow (conductivity lower than 30 µS) this sensor system causes the **shutoff of the machine**, to protect it from running with an interrupted or inadequate water supply.
In this situation the **AØ1 alarm code on display** will glow to warn of the machine shutoff and the reason why.

C. CONDENSER TEMPERATURE SENSOR - WHITE TWO POLES CONNECTOR - MANUAL RESET

The condenser temperature sensor probe, located within the condenser fins detects the condenser temperature variations and signals them by supplying current, at low voltage, to the P.C. BOARD.

In relation to the different current received, the micro processor of the P.C. BOARD supplies, through a TRIAC, the power at high voltage to the fan motor so that it can cool the condenser and reduce its temperature.

In the event the condenser temperature rises and reaches 70°C the current arriving to the micro processor is such to cause an immediate and total stop of the machine operation with the glowing of the AØ3 Alarm Code on display.

NOTE. To restart the unit after the shutoff caused by the hi condenser temperature, it is necessary (after having remedied to the causes of unit stoppage) to switch OFF and ON the power line main disconnect Switch.

D. GEAR MOTOR ROTATION AND SPEED SENSOR - RED FOUR POLES CONNECTOR - MANUAL RESET

This safety device is housed on top of the Drive Motor and detects - based on Hall Effect principle - the rotating speed and rotating direction of the drive Motor.

Should the rotating speed drop below 1300 r.p.m. the magnitude measured by this device is such to signal to the microprocessor to stop the unit and light-up A1Ø Alarm Code. The same reaction occurs when the drive motor will tend to rotate in the wrong direction (counterclockwise) or it doesn't rotate at all.

NOTE. To restart the unit after the shutoff caused by this safety device, it is necessary first to eliminate the cause that has generated the intervention of the device and switch OFF and ON the power line main disconnect switch.

E. ICE LEVEL CONTROL – BLACK FOUR POLES CONNECTOR – AUTOMATIC RESET

The electronic ice bin level control, located under the plastic bin cover, has the function to stop the operation of the ice machine when the light beam between the light source and the sensor gets interrupted by the ice which accumulates in the spout. When the light beam gets interrupted for as long as 10 seconds, the compressor stops immediately and the drive motor keeps on working by 3' delay then stops. On the display appears BF1 code to monitor the full ice bin situation. The 10 seconds of initial delay prevents that any minimum interruption of the light beam due to the regular ice chuting through the ice spout may stop the operation of the unit. As soon as the ice is dispensed out with the resumption of the light beam for 10 seconds between the two infrared sensor of ice level control a BF2 code appears on display. After that, the unit resume its operation with the standard starting delay.

AUTOMATIC CALIBRATION OF THE ICE LEVEL CONTROL

The P.C. BOARD performs the Automatic Calibration with the Infrared Optical Ice Level Control at any start-up of the machine through the ON/OFF Green Push button except when the bin is already full of ice during the restart.

Every time power is provide to the PC Board, it checks automatically the physical condition of the Optical Ice Level Control and self-adjust the current transmitted so to assure the correct operation of the Optical Ice Level Control. FØ2 will appear on display during this phase.

F. ICE/WATER OPTICAL DISPENSING DEVICES (ONLY FOR TOUCH LESS VERSION)

Located on the front of the dispensing area it consists of the combination of an infrared Transmitter and Receiver.

When a glass or a carafe is placed in front of the Infrared sources, the optical device transmits a signal to the PC Board that is equivalent to activate the dispensing drive motor which, in turn, put in rotation a dispensing vane that pushes the ice towards a rectangular opening located in the bottom of the storage bin.

Elapsed the dispensing time or after have removed the glass/carafe, the infrared resume its original condition switching off the dispensing drive motor.

The PC Board of the control panel operates the capacitive keys, LEDs, infrared sensor and the connection with the power PC Board of the dispenser, managing the dispensing mode of ice and water and showing any alarm occurred.

DISPLAY LAYOUT

Here below the layout of the display and a resuming charts with the meaning of each item during the standard operation of the dispenser and when in the Menu Program.

G. CONTROL PANEL

Located in the rear side of the upper front part of the dispensing area it is composed by one PC Board with microprocessor and an external user interface display panel with capacitive keys.

CONTROL PANEL PC BOARD LAYOUT

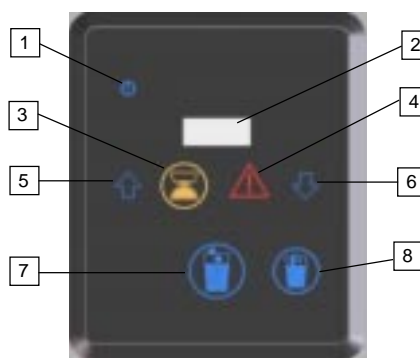
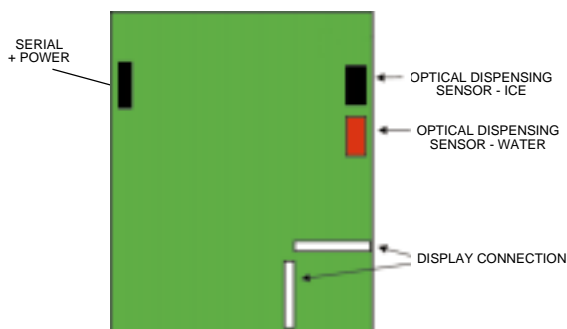

Pos.	Description	Touch version	Touchless version	Menu program
1	ON-OFF Light	ON	ON	ON
2	7 segment-3 digit display	OFF	OFF	ON
3	Bin Empty Light	ON during the first 15" and when the bin is empty	ON during the first 15" and when the bin is empty	ON
4	Alarm Capacitive key	Normally OFF - ON in case of alarm	Normally OFF - ON in case of alarm	ON
5	Up Arrow Capacitive key	OFF	OFF	ON Used to move up in Menu Program
6	Down Arrow Capacitive key	OFF	OFF	ON Used to move down in Menu Program
7	Ice Dispensing Capacitive key	Normally ON It blinks when unit dispenses ICE	Normally OFF It blinks when unit dispenses ICE	ON Used to confirm (enter)
8	Water Dispensing Capacitive key	Normally ON It blinks when unit dispense WATER	Normally OFF It blinks when unit dispense WATER	ON Used to cancel (ESC)

The control panel is used to operate the power PC Board of DXN machines; the interaction with the user takes place by means of the capacitive keys (Dispensing Ice, Dispensing Water, Alarm, Delay, Up & Down Arrows), while the feedback to

the user is provided through the LEDs placed behind each button and the 7-segment 3-digit display. The panel also provides to manage the presence of glass sensors (touchless version), one for the water and one for the dispensing of the ice.

MENU PROGRAM

Through the menu program it is possible the setting of the machine operating parameters, and view/clear some counters.

To enter in MENU program, press the ALARM button, even if it is OFF for 10". Entering in the programming mode the display will turn ON all LEDs except ALARM and DELAY. Use the UP

and DOWN capacitive keys to navigate through the menu and choice of parameter values, ICE key is used to select and confirm the selection, WATER key to cancel or ESC.

Pushing the ICE key the selected value will flash and will be saved as the current value for the parameter and return to the list main parameters. Push WATER key for more than 5 seconds to return to operating mode.

Menu Program Description	Display	Option 1	Option 2	Default Setting
Dispensing Water	H	On: water dispensed	Off: water disabled	On
Touch or Touchless version	F	Tch : Touch	TcL : Touchless	tch
Dispensing time	S	1 up to 15 seconds	CON= continuous	3 sec.
Machine model	-d-	100 = DXN 100	200 = DXN 200	100 *
Menu Program Description	Display	Meaning and reset mode		
Compressor working hours	C	Shows the current working hours of compressor Push ICE key to reset the counter		
PC Board working hours	P	Shows the current working hours of main PC Board Push ICE key to reset the counter		
Dispensing drive motor working hours	I	Shows the current working hours of dispensing drive motor Push ICE key to reset the counter		
Cleaning Remind	C L E	Push ICE key to reset the counter before the cleaning time is elapsed		
Firmware version	-U-	Shows the current version of the firmware installed on the main PC Board of the machine		

* There is a third option choosing "000" the bin empty function will be disabled

Display Counter Reading Mode

Compressor, PC Board and Dispensing Drive Motor current working hours can be read on display through its three digits and dots.



As per following meaning:

- Digits are working hours
- Dots are decimals to add

I.e.

999 = 999 working hours

999. = 9990 working hours

99.9. = 99900 working hours

OPERATING STATUS

Using the capacitive keys on display is possible to know at what stage the machine is operating, except during an active warning alarm.

To do it, push the Red Alarm Key for 5 seconds

when it is OFF, the display will show the code of the current status of the machine:

Status	Display Code
Firmware version	Pxx
Start-up Delay (purge time)	d01
Start-up Delay (fill up time)	d02
Water Error (when no water is detected)	F06
Ice level control beam interrupted	F05
Bin Full	bF1
Ice level control beam resumed	bF2
Start-up	F03
Start-up checks	F01
Making ice	F04
Ice level control auto calibration	F02
Water reservoir drain	Pur

The Display automatically will switch off after 5 seconds.

CLEANING REMIND

The need to clean the machine is signaled by the LED ALARM and "CLE" on display after 6 months of operation. When this remind appear, the machine and the panel nevertheless continue to

function normally. To reset the remind, go into alarm (by pressing the ALARM key for 5") and while displaying the "CLE" condition simply press the ALARM button for more than 5". The completion of the reset signal is confirmed by 3 flashes of "rES" on display.

ALARM CONDITION

All the alarm codes are signaled by the ALARM key; push it for more than 5 seconds to turns ON the display, which shows the code alarm in progress.

The alarm codes are the following:

Alarm	Code
No Water	A01
Evaporator Sensor out of order	A02
Condenser Sensor out of order	A03
Optical dispensing Sensor out of order (ICE)	A04
Optical dispensing Sensor out of order (WATER)	A05
Too High Evaporator Temperature (> 0°C)	A06
Too Low Evaporator Temperature (< - 30°C)	A07
Too High Condensing Temperature (> 70°C)	A08
Too Low Condensing/Ambient Temperature (<3°C)	A09
No /Wrong Rotation Alarm	A10
Too High Condensing Temperature at start-up (> 55°C)	A11
Test Alarm	A14
Ice level control out of order	A15
Cleaning Remind (6 months)	CLE

After 5" the display will turn off and only the keys of the standard operation will remain lighted .

H. P.C. BOARD

THE P.C. BOARD, fitted in its galvanized steel box located in the right side of the unit, consist of two separated printed circuits one at high and the second at low voltage protected by a fuse.

It also consists of 3 aligned LEDS monitoring the operation of the machine and of input terminals for the leads of the sensor probes as well as input and output terminals for the leads of ice maker electrical wires. The P.C. BOARD is the brain of the system and it elaborates, through its microprocessor, the signals received from the sensors in order to control the operation of the different electrical components of the ice dispenser (compressor, gear motor, fan motor, water valves, dispensing devices).

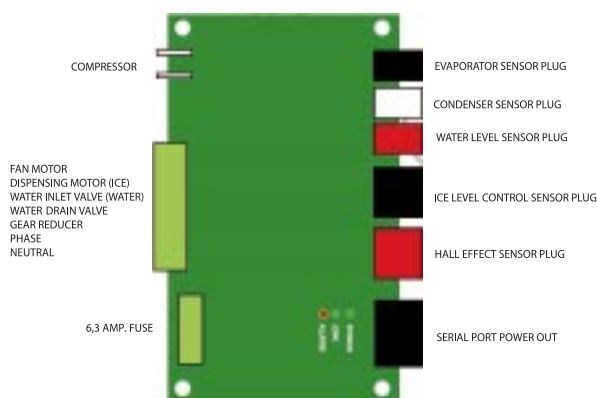

The three LEDS, placed in a row in the center of the P.C. BOARD, monitor the following situations:

Green ON/OFF = Power ON or OFF

Green LINK = Normally ON; detects the connection with the control panel interface board

Red ALARM = Normally OFF; will be ON in case of any alarm

I. FLOAT RESERVOIR

The float reservoir consists of a plastic water pan on which is fitted a float valve with its setting screw. The float valve modulate the incoming water flow to maintain a constant water level in the reservoir, level that corresponds to the one in the freezing cylinder to ensure proper ice formation and fluidity.

On the inner side of the reservoir cover are fitted the two water level sensors which detects the presence or the shortage of water in the reservoir.

NOTE. It is very important to make sure of the correct fitting of the cover on the reservoir in order to enable the sensor to efficiently control the water situation avoiding undue shutoff interventions.

J. FREEZING CYLINDER (EVAPORATOR)

The freezing cylinder is made of a stainless steel vertical tube with an inner evaporating chamber and in its interior is located the auger which rotates on its vertical axis and it is maintained aligned by the top permanently lubricates bushings and a ball bearing. A water seal system is located in the bottom part of the freezer.

The water constantly flowing into the cylinder bottom part, freezes into ice when in contact with the cylinder inner walls. The ice is then lifted up by the rotating auger and compacted and forced out by the ice breaker.

K. ICE BREAKER

The ice breaker is made by several rectangular openings where the ice is forced to pass through.

By undergoing this, the ice loses its excess of water content so it drops into the bin in hard dry bits of ice.

L. DRIVE GEAR MOTOR

This motoreducer is made of a single phase electric motor with permanent capacitor directly fitted on a gear box.

The drive motor rotor is kept aligned on its vertical axis by two ball bearings permanently lubricated. The gear case contains a train of three spur gears the first one of which is in fiber to limit the noise level. All the three gears are encased in case bearings and are covered by lubricant oil.

Two seal rings, one fitted on the rotor shaft and the other on the output shaft keep the gear case sealed.

However, the interior can be inspected and serviced by unbolting the two halves of the aluminium gear case housing.

The gear reducer output is connected to the freezer auger that engages themselves only if turned in the correct direction namely, counterclockwise.

M. FAN MOTOR (Air cooled version)

The fan motor is controlled through the P.C. BOARD and the TRIAC by the condenser temperature sensor. Normally it operates to draw cooling air through the condenser fins.

In cold ambient situation, the fan motor can run at intermittance as the condenser pressure must be kept between two corresponding head pressure values.

N. COMPRESSOR

The hermetic compressor is the heart of the refrigerant system and it is used to circulate and retrieve the refrigerant throughout the entire system. It compresses the low pressure refrigerant vapor causing its temperature to rise and become high pressure hot vapor which is then released through the discharge valve.

O. ICE DISPENSER DRIVE MOTOR

Located on the lower side of the storage bin, it turn by a milled shaft the dispensing vane placed inside the round storage bin.

By rotating, the dispensing vane pushes the ice towards the bottom rectangular opening so to force the nugget ice to go through the bottom outlet spout.

P. STORAGE BIN

Round shaped it is located in the front of the ice machine and has the main reason to store the ice

produced by the evaporator till it reaches its maximum level controlled by an infrared optical system. In its bottom is placed the ice spout as well as the water drain hole.

Inside the ice spout opening is also located the water outlet tube connected to the solenoid valve.

Q. DISPENSING WATER SOLENOID VALVE

Normally closed and located in the upper left side behind the front panel, it is energized and controlled by the P.C. Board, it allows a metered quantity of not chilled water to be dispensed through its spout.

R. WATER INLET SOLENOID VALVE

Normally open and located in the lower side of the rear panel, it is energized and controlled by the P.C. Board, it allows the entrance of the water in water circuit of the machine for the ice production.

S. WATER DRAIN SOLENOID VALVE

Normally closed and located in the lower side of the rear panel, it is energized and controlled by the P.C. Board during the purge procedure during every start-up of the machine when it is switched ON and every twelve hours of operation. It drain all the water from the reservoir and freezer to prevent the growth of bacteria and algae when machine is not working for many hours (Night-time and/or Bin full condition).

T. SAFETY P.C. BOARD

Located on the rear side of the machine, it is connected with safety switch and ON/OFF green push button to let them work with low voltage for safety reason.

WIRING DIAGRAM - DISPENSING BOARD VERSION AIR AND WATER COOLED 230/50/1

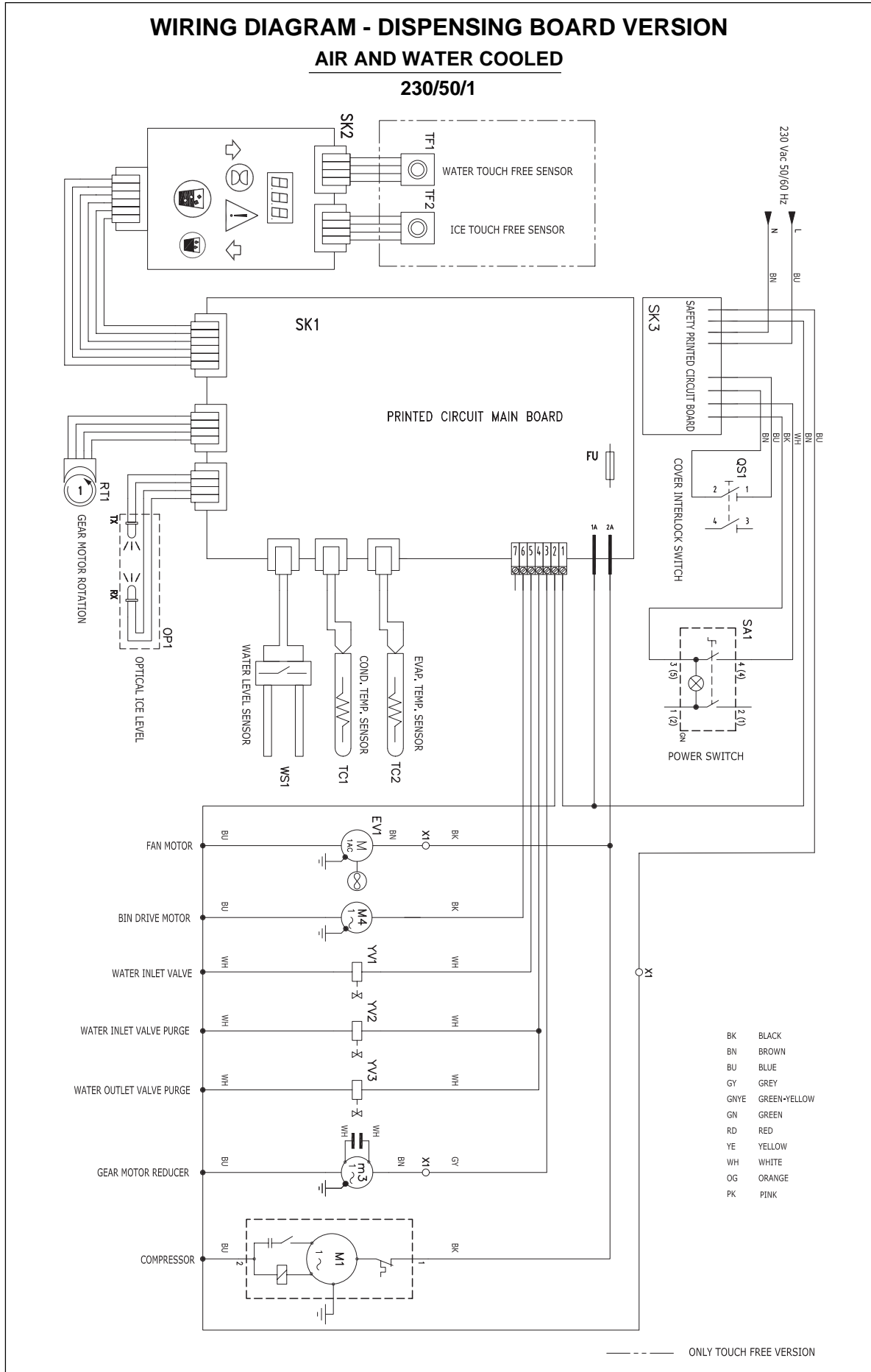

SERVICE DIAGNOSIS

SYMPTON	POSSIBLE CAUSE	SUGGESTED CORRECTION
Unit will not run No LED lighted-up BF1 Code AØ1 Alarm Code AØ8 Alarm Code AØ6 Alarm Code A1Ø Alarm Code	Blown fuse in P.C.Board	Replace fuse & check for cause of blown fuse
	Master switch in OFF position	Turn switch to ON position
	Inoperative P.C.Board	Replace P.C.Board
	Loose electrical connections	Check wiring
	Dirty ice level control	Clean ice level control
	Shortage or too soft water	See remedies for shortage of water or install a mineral salt metering device
	High head pressure	Dirty condenser. Clean Inoperative fan motor. Replace
	Too hi evap. temperature Shortage or lack of refrigerant	Check and charge refrigerant system
	Gear motor tends to run on reverse	Check gear motor capacitor
	Too low gear motor rotating speed	Check rotor bearings, freezer bushings and interior of freezer for scores. Replace whatever worn or damaged.
No rotation of gear motor	Check for power to drive motor (16 A fuses) Check for stator winding	
Gear motor starts and stop after a while	Check for correct operation of drive motor magnetic sensor Check for correct magnetic capacity of magnetic cylinder	
Compressor cycles intermittently	Low voltage	Check circuit for overloading Check voltage at the supply to the building. If low, contact the power company
	Non-condensable gas in system	Purge the system
	Compressor starting device with loose wires	Check for loose wires in starting device
Low ice production	Capillary tube partially restricted	Blow charge, add new gas & drier, after evacuating system with vacuum pump
	Moisture in the system	Same as above
	Low water level in the freezer	Adjust to approx 20 mm below ice spout
	Shortage of refrigerant	Check for leaks & recharge
	Pitted or stained auger surface	Clean or replace auger

SERVICE DIAGNOSIS

SYMPTON	POSSIBLE CAUSE	SUGGESTED CORRECTION
Wet ice	Ambinet temperature too high High water level in the freezer Faulty compressor	Move unit to cooler location Lower to approx. 20 mm below ice spout Replace
Machine runs but makes no ice	Water not entering in the freezer Gear stripped Moisture in the system	Air lock in feed line to freezer. Clogged feed line to freezer. Clean it Check and repair Purge, replace drier and re-charge
Water leaks	Water seal leaking Water feed line to freezer leaking Float valve not closing	Replace water seal Check and fasten hose clamp Check and adjust float valve setting screw
Excessive noise or chattering	Mineral or scale deposit on auger and inner freezer walls Low suction pressure Water feed line to freezer clogged Low water level into freezer	Remove and manually polish auger and inner walls of freezer barrel using emery paper Add refrigerant to rise suction pressure Vent and clean it Adjust to approx. 20 mm below ice spout
Gear motor noise	Worn rotor bearings Shortage or poor lubricant in gear case Gear case bearings and gear racers worn out	Check and replace Check for proper lubricant opening gear case. Top of gears must be covered with lubricant Check and replace worn parts
Shortage of water	Strainer at water inlet fitting clogged Float reservoir water nozzle clogged-up	Remove strainer and clean Remove float valve and clean nozzle

MAINTENANCE AND CLEANING INSTRUCTION

A. GENERAL

The periods and the procedures for maintenance and cleaning are given as guides and are not to be construed as absolute or invariable.

Cleaning, especially, will vary depending upon local water and ambient conditions and the ice volume produced; and, each icemaker must be maintained individually, in accordance with its particular location requirements.

WARNING: Before proceeding with any cleaning and maintenance operation, make sure that electrical power has been disconnected.

CAUTION. DO NOT use a pressurized water jet system for the cleaning of the machine

B. DAILY MAINTENANCE

It must be performed by the end user and consists of cleaning and sanitizing of the frame and the dispensing parts of the unit.

1. Wipe the exterior of the machine with a disposable sanitizing wipe using a specific product for Stainless Steel cleaning.
2. Remove the ice and water spouts



And allow to soak in a sanitizing solution for 10 minutes, then rinse well with fresh water.

3. Pour hot soapy water or sanitizing solution into the drain pan ensuring not to overflow the tray.



4. Remove the drip tray and the grill, clean the filter on the drain fitting

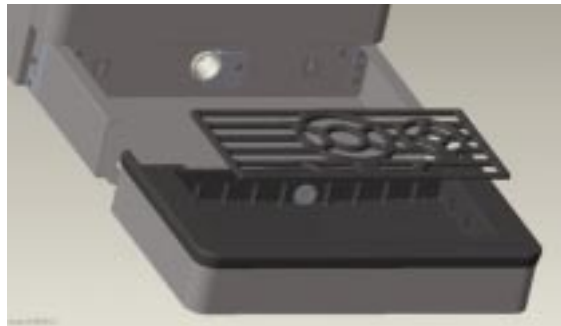

Allow to soak the removed parts in a sanitizing solution for 10 minutes, then rinse with fresh water.

5. If necessary, use a sanitized brush, carefully insert into the drain hole to clear any solidified build-up of debris from the drain tubes.



6. Reinstall grill, drip tray and the ice & water spouts ensuring that the underside dispensing area is thoroughly cleaned and sanitized.

C. MONTHLY MAINTENANCE

It must be performed by the user of the DXN Dispenser, and consists of cleaning and sanitizing the ice bin area.

Tools required: Scotsman Sanitizer, gloves, carafe.

1. Close the water tap first; through the green ON/OFF button turn OFF the machine; wait 30 seconds then switch ON again.

2. Machine starts to purge the water from the reservoir, wait 2 minutes, then extract the upper section of the front panel, unscrew the two fastening screws and remove the top panel, the machine will automatically switch OFF.

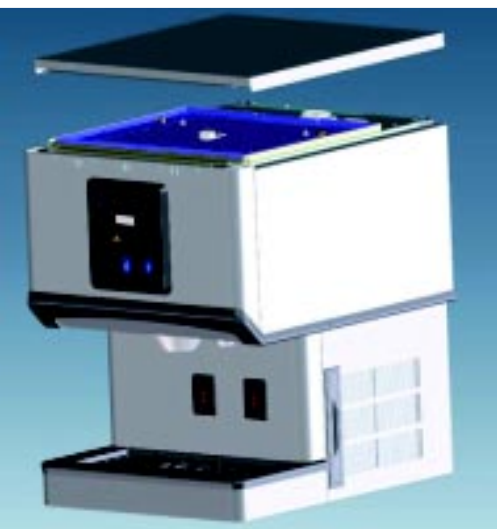
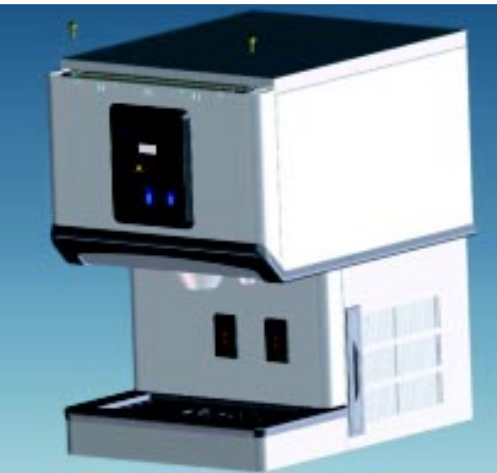
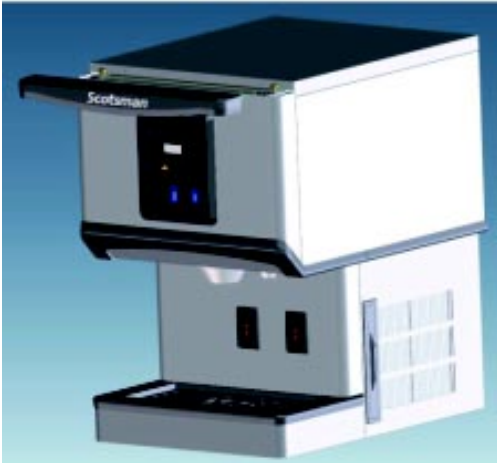

3. In a carafe, prepare 500 ml of warm water (40-50°C) and 15 ml of Scotsman Sanitizing product and wait at least 10 minutes.

4. Open the plug of the funnel and pour the sanitizing solution in the reservoir.

5. Unscrew the two fastening screws and remove the bin cover

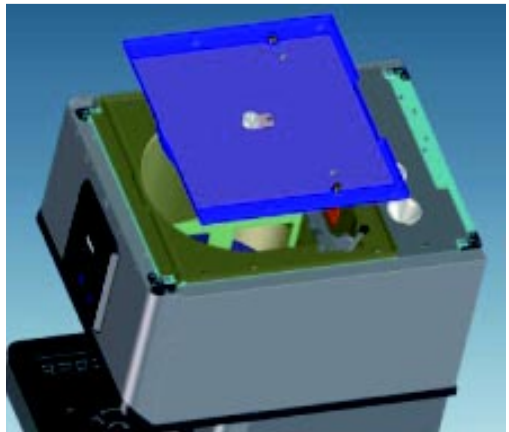
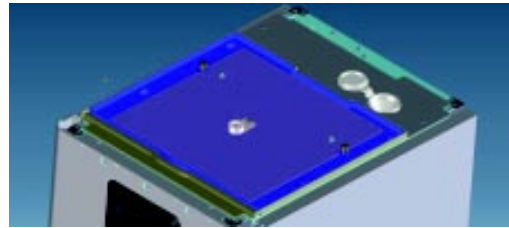

6. Lift up the ice level control and its bracket from its housing and carefully stand it on the frame of the unit.

Remove ice, distribution vane and steel bottom from the storage bin.

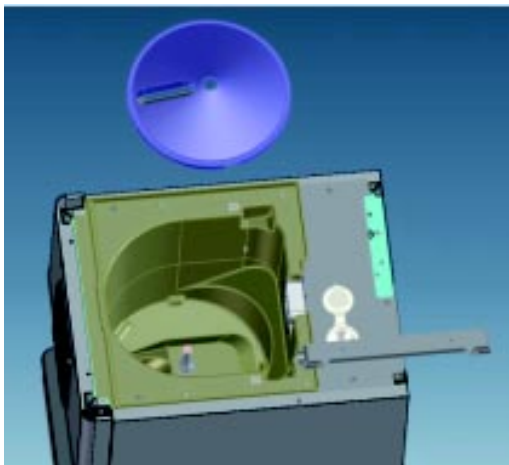
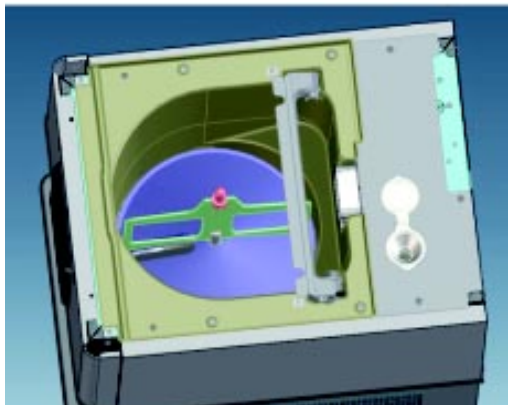

7. Using the same carafe, prepare again 500 ml of warm water (40-50°C) and 15 ml of Scotsman Sanitizing product and pour of the solution on the internal sides of the storage bin.

8. Using a sanitised disposable cloth, clean the ice bin and rinse with clean water.

9. Close the funnel plug and reinstall all the previously removed panels and parts by following the procedure in reverse order, paying attention that both the steel bottom and the upper shaft of the blade are properly seated.

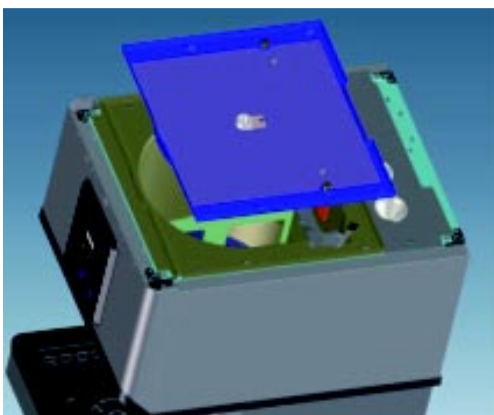
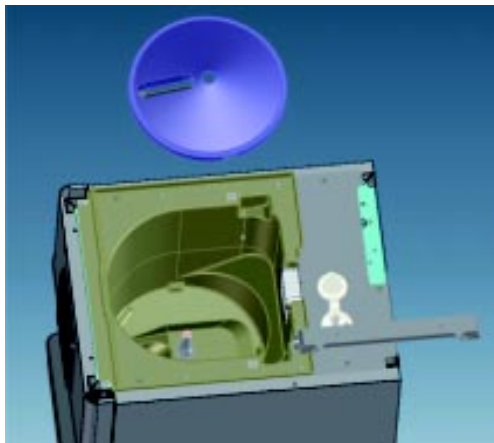

10. Remove, clean and reinstall the air filter located on the right side panel, then open the water tap.



11. Remove, clean and re-install the snorkel located in the water dispensing tube using the special key (P/N SC 651647 02) supplied to all DXN.

NOTE. Once the cleaning operations are completed, switch on the equipment; the ice production process will start after a delay of ten minutes. Make sure that the first produced ice doesn't taste slightly acid; in any case empty the bin by pressing the dispensing button and dispose of the ice produced during the first 10 minutes.

D. TWICE A YEAR MAINTENANCE

After six months of operation of the unit's compressor, the Dispenser will indicate the need to carry out the cleaning of the water circuit and some checks of the machine.

On the display will appear a "CLE" as a Cleaning Remind ensuring in the meantime the standard operation of the machine.



Touchless Version



Touch Version

The following maintenance procedure should be performed every time the Cleaning Remind appear by an authorized Scotsman Service.

1. Check and clean the water line strainer.
2. Remove the cover from the float reservoir - care to do not damage the two water sensors - and depress the float to make sure that a full stream of water enters into the reservoir.
3. Check that the icemaker is levelled in side to side and in front to rear directions.
4. Check that the water level in the water reservoir is below the overf low but high enough that it does not run out of the spout opening.

NOTE. The float must close positively the incoming water flow when the rubber housed in the setting screw, is perpendicular to the water nozzle.

5. Clean the water system, water reservoir and the interior of freezing cylinder using a solution of SCOTSMAN Ice Machine Cleaner. Refer to following procedure (E) cleaning instructions and after cleaning will indicate frequency and procedure to be followed in local areas.

NOTE. Cleaning requirements vary according to the local water conditions and individual user operation.

6. If necessary, polish the two sensor rods secured to the float reservoir cover, heavy scale sediment on them can be removed with the help of a bit of SCOTSMAN Cleaner.
7. Check for water leaks and tighten drain line connections. Pour water into the drip tray to be sure that drain line is open and clear.

8. Check the ice level control sensor to test shut-off. Put your hand between the light source and the receiver so to cut off the light beam for at least 10 seconds. This should cause the immediate bin full condition with a bF1 on display. The compressor stops immediately and the gear reducer three minutes later. Within few seconds from the removal of the hand from between the sensor lights the ice maker resume its operation with the standard 8 minutes of the start-up delay.

NOTE. *The ice level control uses devices that sense light, therefore they must be kept clean enough so they can "see". Every month clean/wipe the sensing "eyes" with a clean soft cloth.*

9. Check for refrigerant leaks and for proper frost line, which should frost as far as approx. 20 cm (8") from the compressor. When doubtful about refrigerant charge, install refrigerant gauges on corresponding Schröder valves and check for correct refrigerant pressures.
(See Operating pressure at page 12 of this manual).
10. Check that fan blades move freely and are not touching any surfaces.
11. Turn the ice dispensing spout and remove it. Wash and sanitize it as shown at point B
12. Remove the drip tray and grill for washing and sanitizing as shown at point B.

E. CLEANING INSTRUCTIONS OF WATER SYSTEM

1. Empty the ice storage bin trough the dispensing button , then switch OFF the unit from the green ON/OFF push button.
2. Remove the top panel and later the top cover of storage bin.
3. Close the water shutoff valve on water line.
4. Remove the left side panel to gain access to the water reservoir.
5. Remove the float reservoir cover and with a piece of copper wire jump the two water level sensors.
6. Switch ON the unit to purge and drain out all water from the freezer.

CLEANING

7. Prepare the cleaning solution by diluting in a plastic container two liters of warm water (45°- 50°C) with a 0,2 liters of SCOTSMAN Ice Machine Cleaner.

WARNING. The SCOTSMAN Ice Machine Cleaner contains Phosphoric and Hydroxyacetic acids. These compounds are corrosive and may cause burns if swallowed, DO NOT induce vomiting. Give large amounts of water or milk. Call Physician immediately. In case of external contact flush with water. KEEP OUT OF THE REACH OF CHILDREN

8. Pour the cleaning solution into the water reservoir funnel till reaches the proper level.
9. After 15 minutes switch ON the Master switch to start the unit.
10. Wait till the machine starts to discharge ice, then continue to slowly pour the cleaning solution into the water reservoir funnel taking care to maintain the level just below the over low.

NOTE. *The ice made with the cleaning solution is slushy and colored also, it may tend to loose fluidity creating some resistance in being elevated and extruded; this situation can be heard by the cracking noise made by the ice. Should this occur it is recommended to stop for few minutes the ice machine in order to allow the ice in the freezer to partially melt.*

11. When all the cleaning solution has been used, open the water shutoff valve to allow new fresh water to flow into the reservoir. Let the unit to continue to run until the ice resumes the normal color and hardness.

12. Stop the icemaker and pour warm water on the ice deposited into the storage bin to melt it up.

NOTE. *DO NOT use ice produced with the cleaning solution. Be sure none remains in the bin.*

SANITATION

13. Once completed the cleaning procedure perform the monthly storage bin sanitizing procedure as described at point (C).

NOTE. *DO NOT use ice produced with the sanitizing solution.*

REMEMBER. To prevent the accumulation of undesirable bacteria it is necessary to sanitize the interior of the storage bin with an anti-algae disinfectant solution every once or at least twice a week.